

High level structure

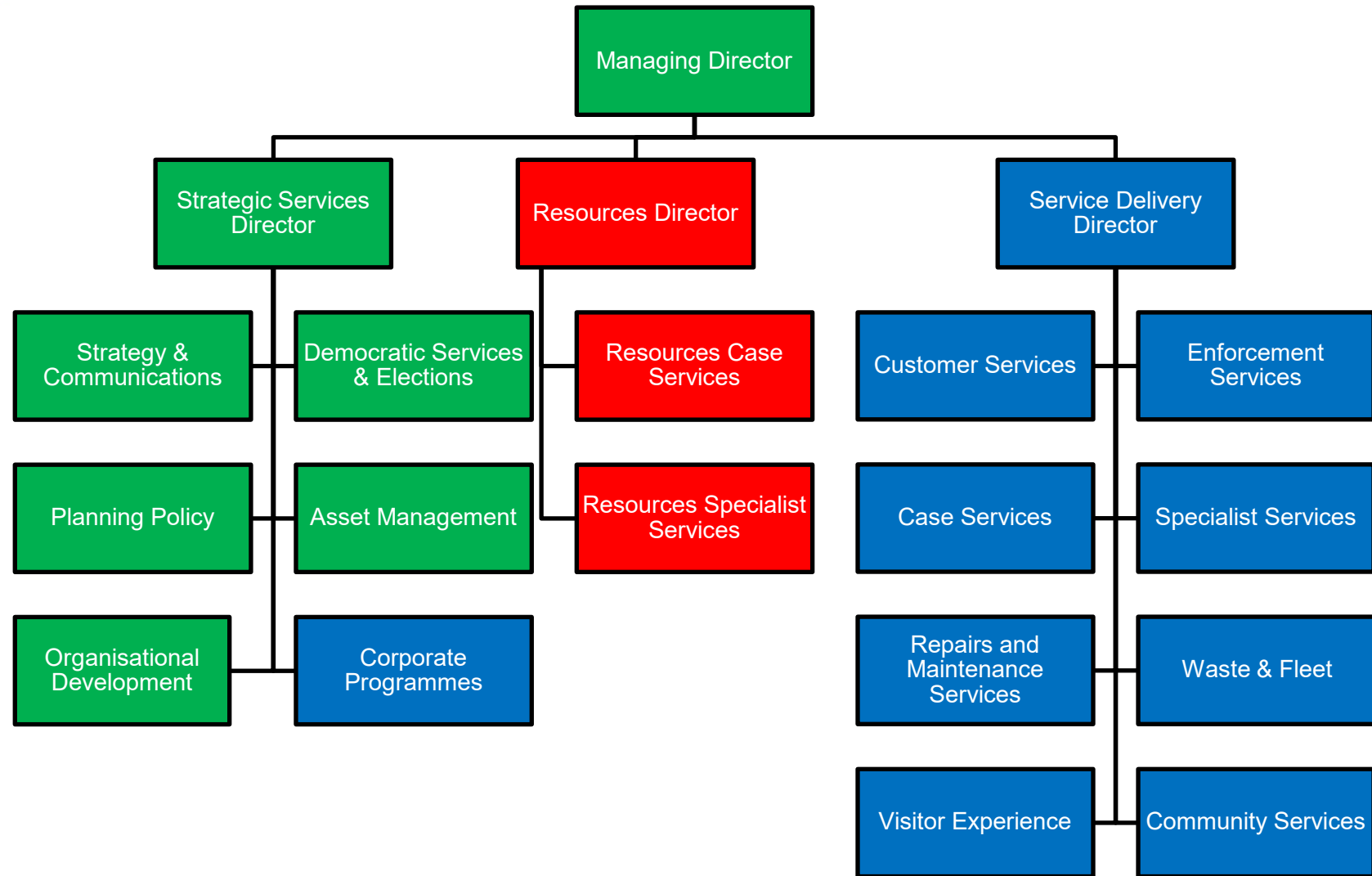

Phase A

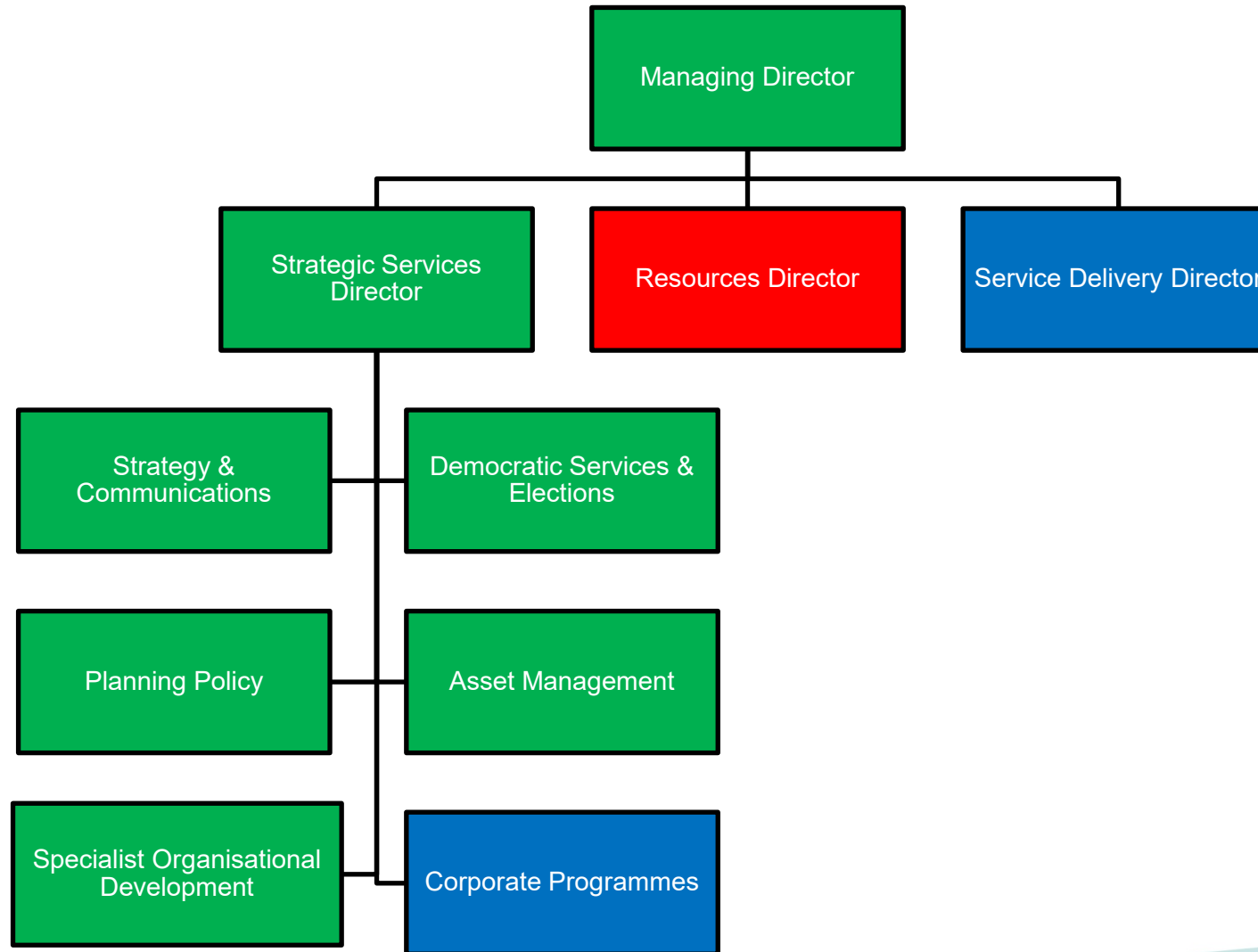

Strategy & Communications Team

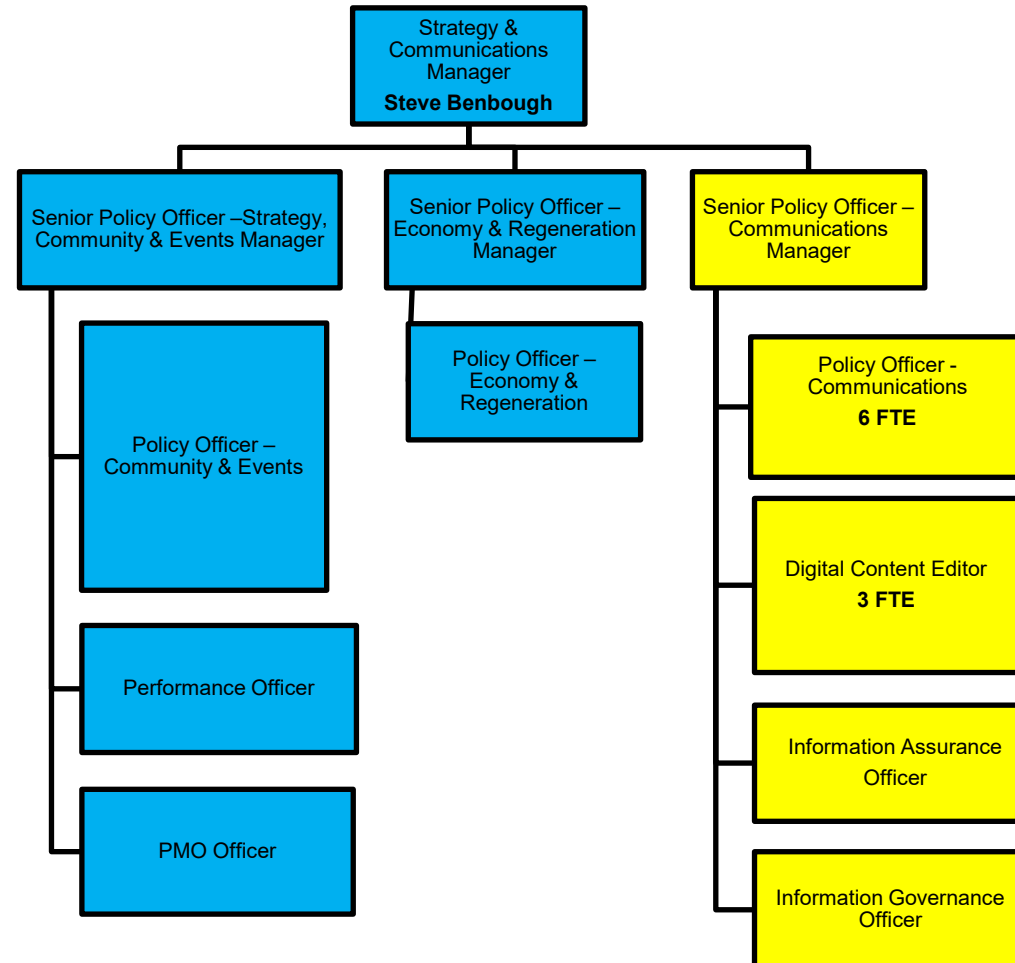

Planning Policy

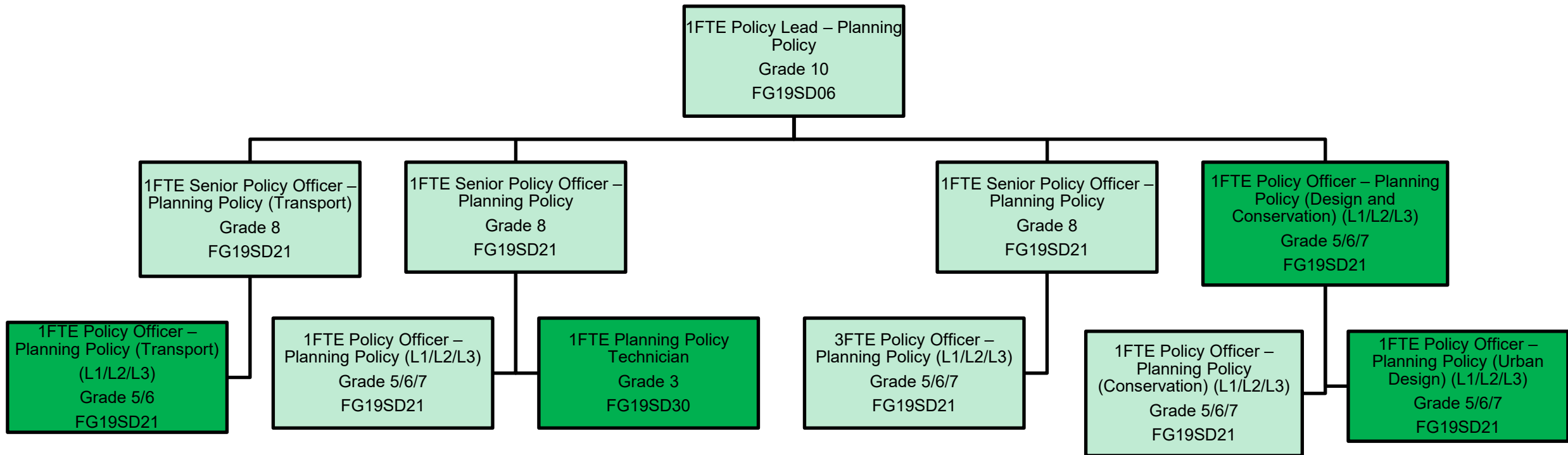

Asset management

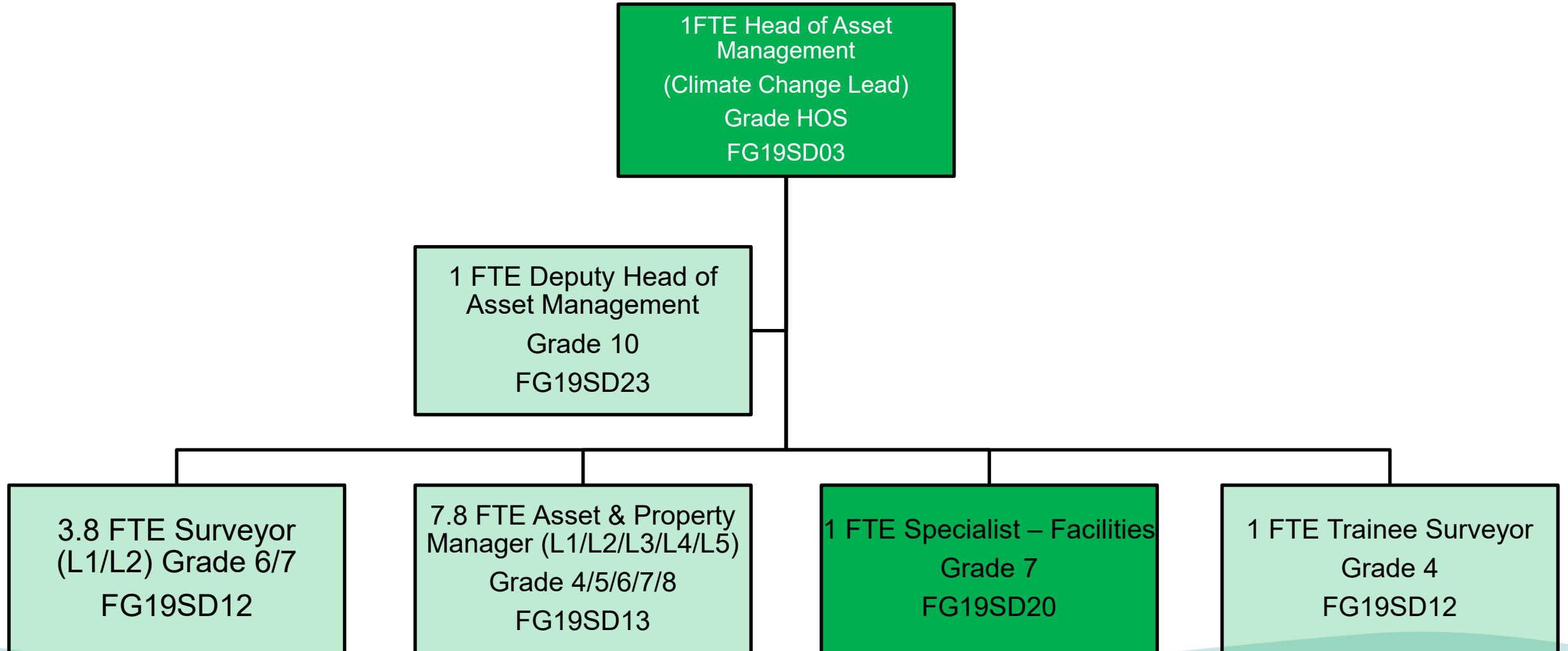

Democratic and elections

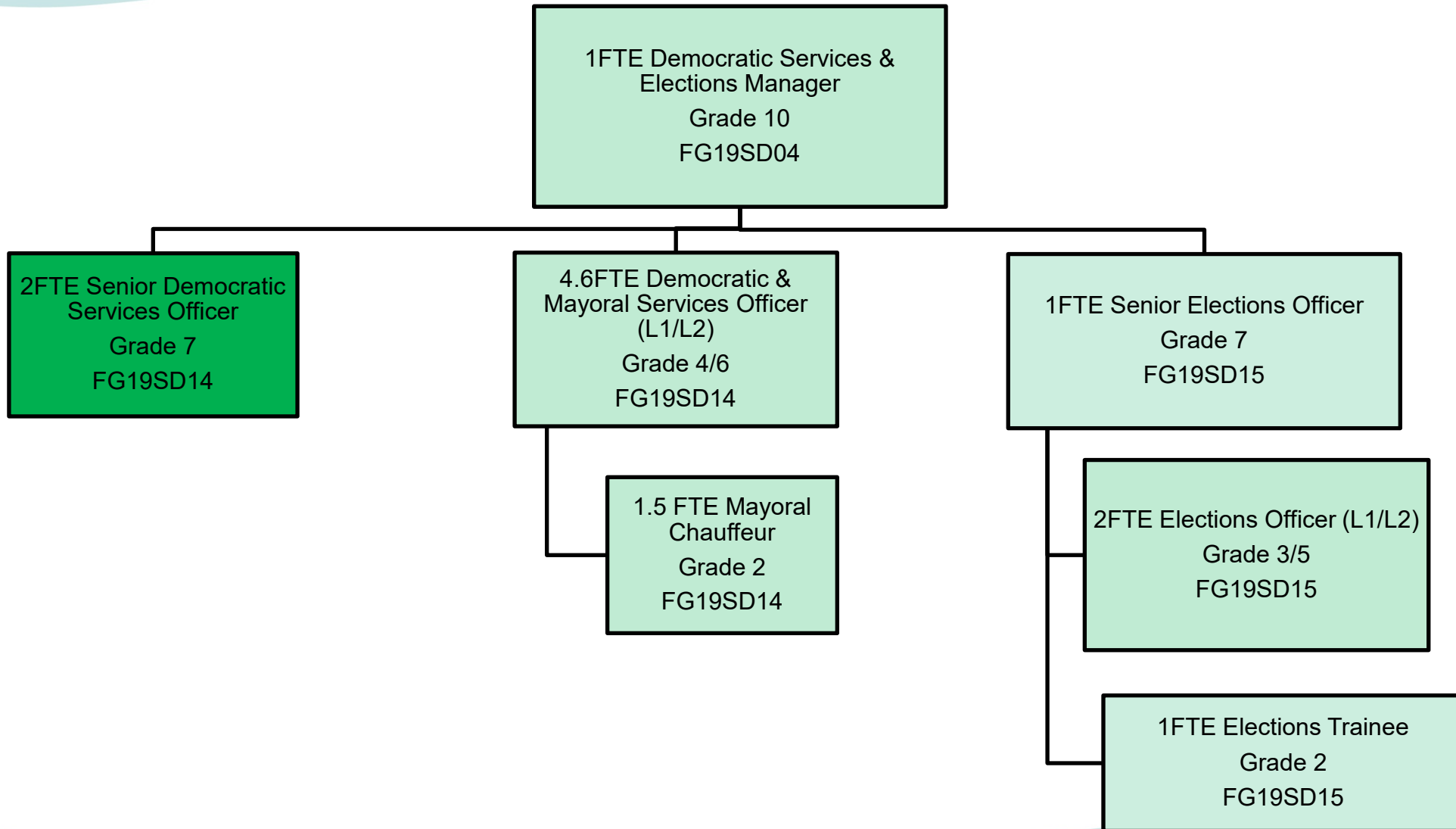

Corporate programmes

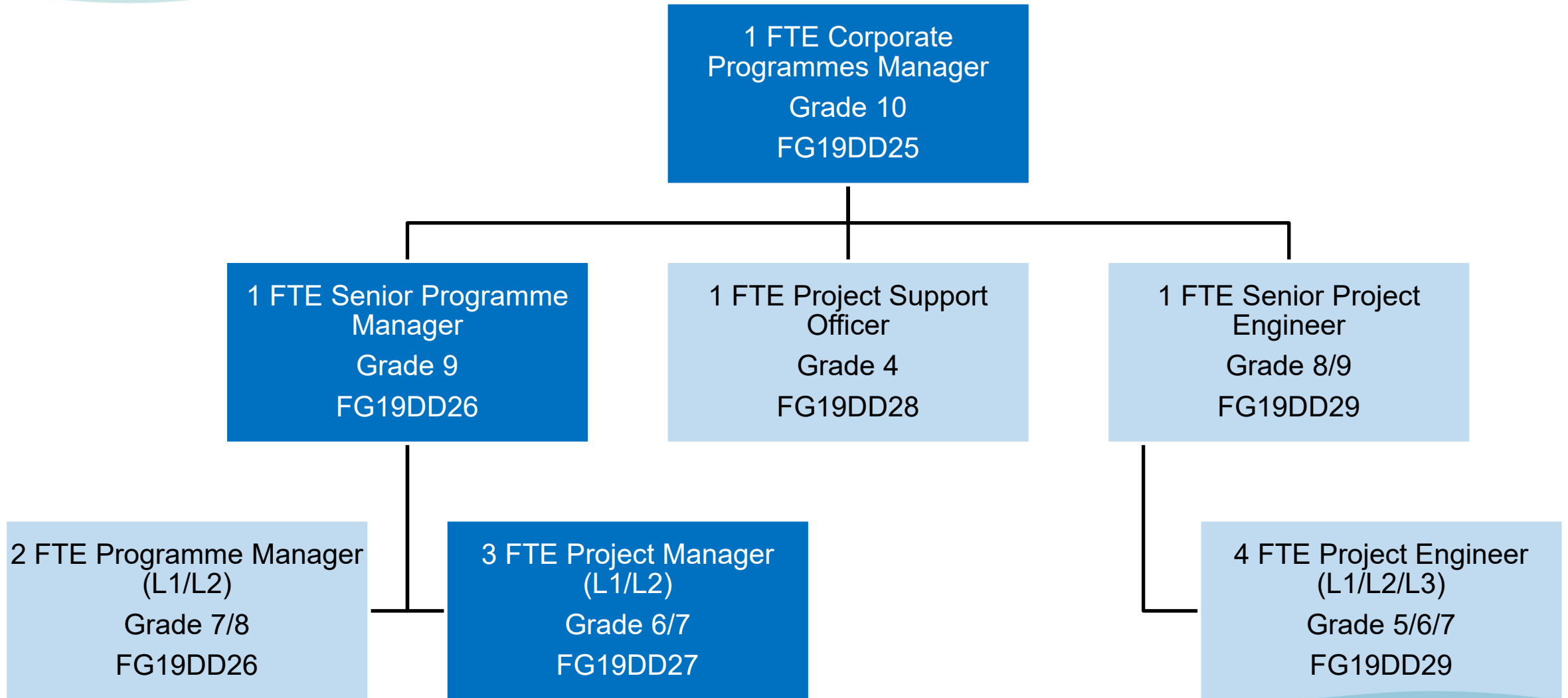

High level structure

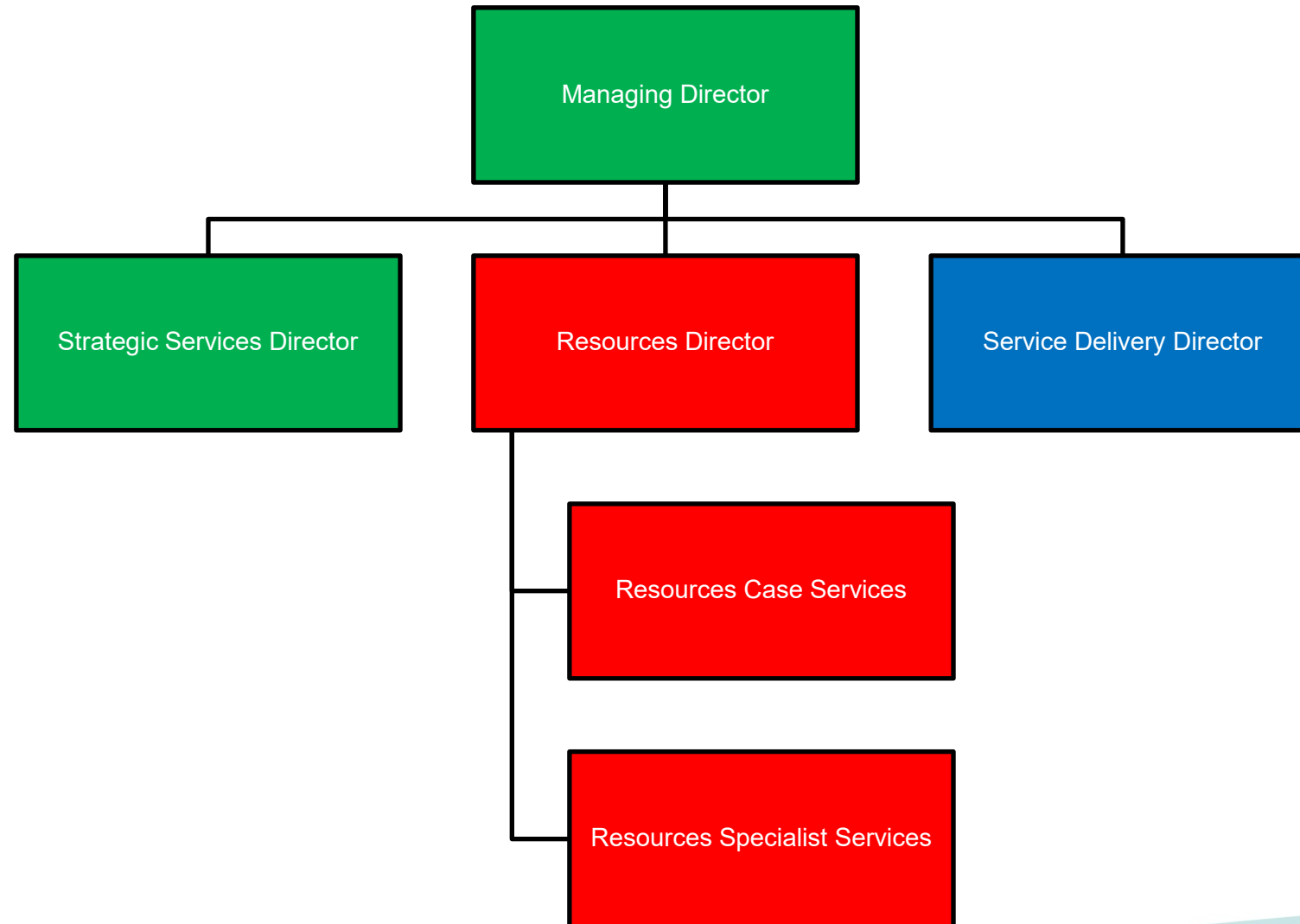

Resources case management

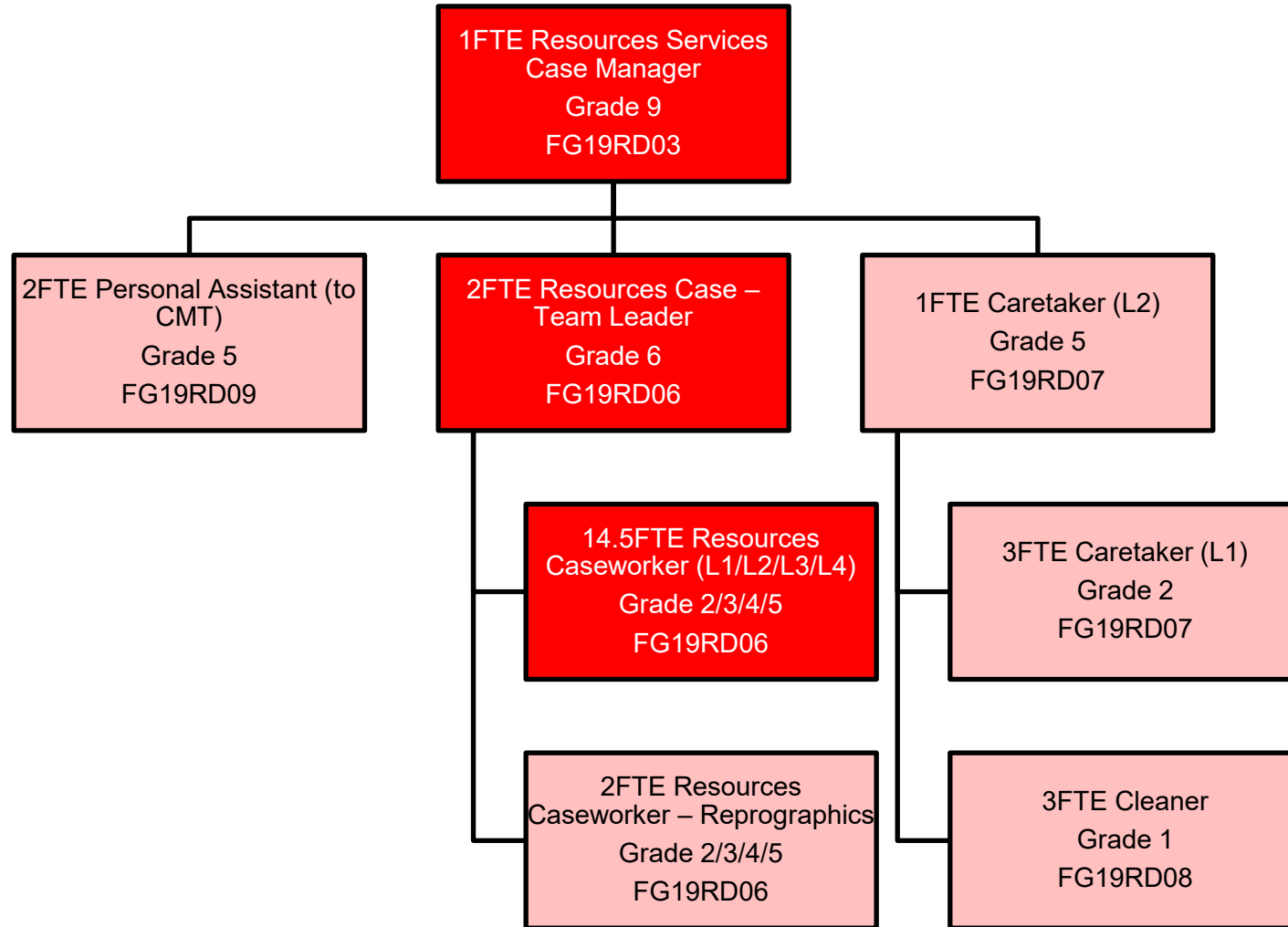

Resources specialists

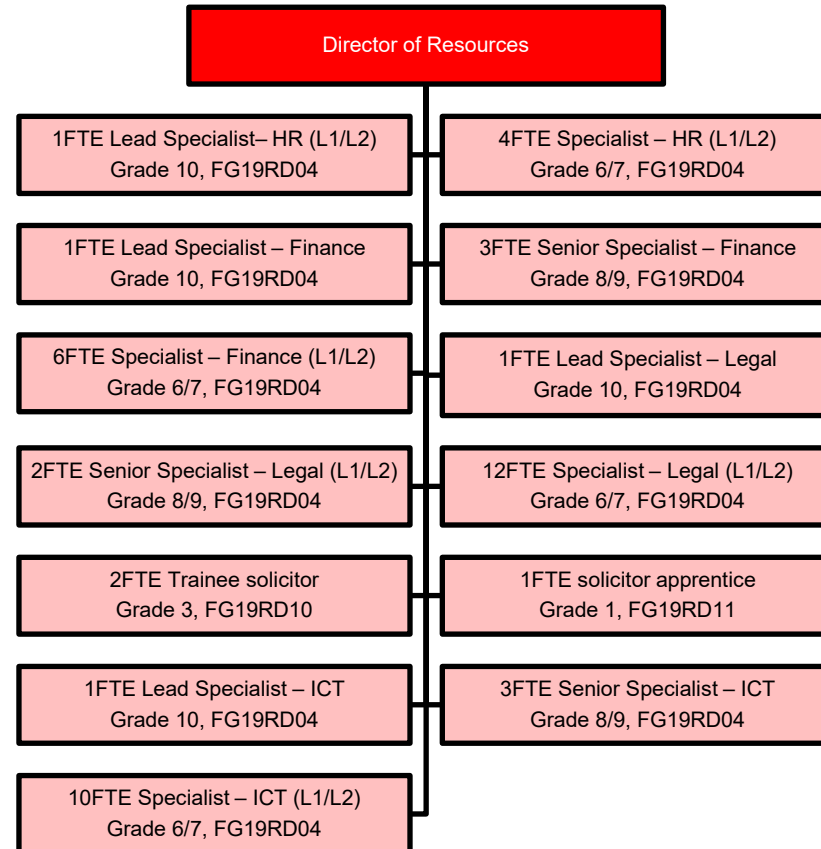

Legal

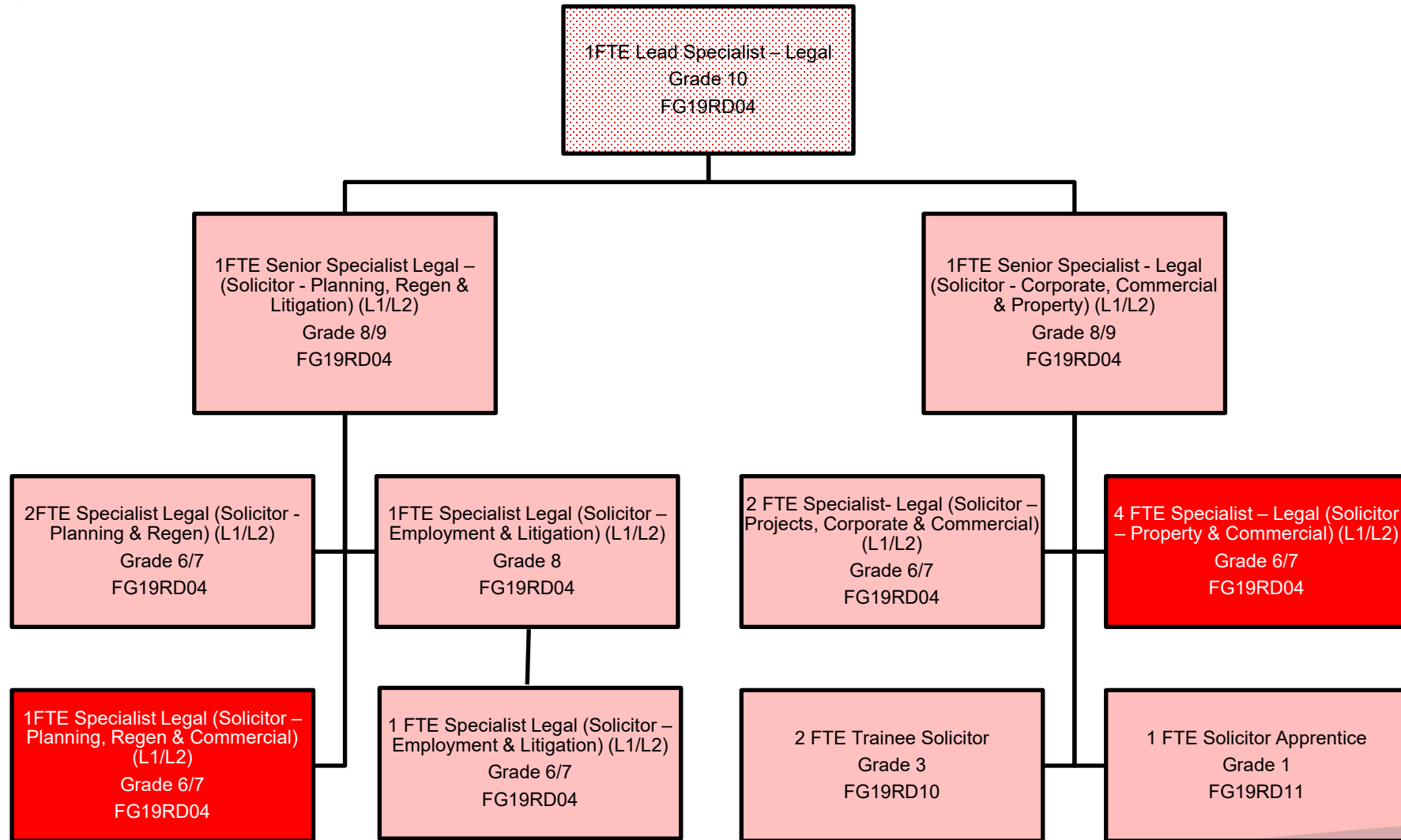

Finance

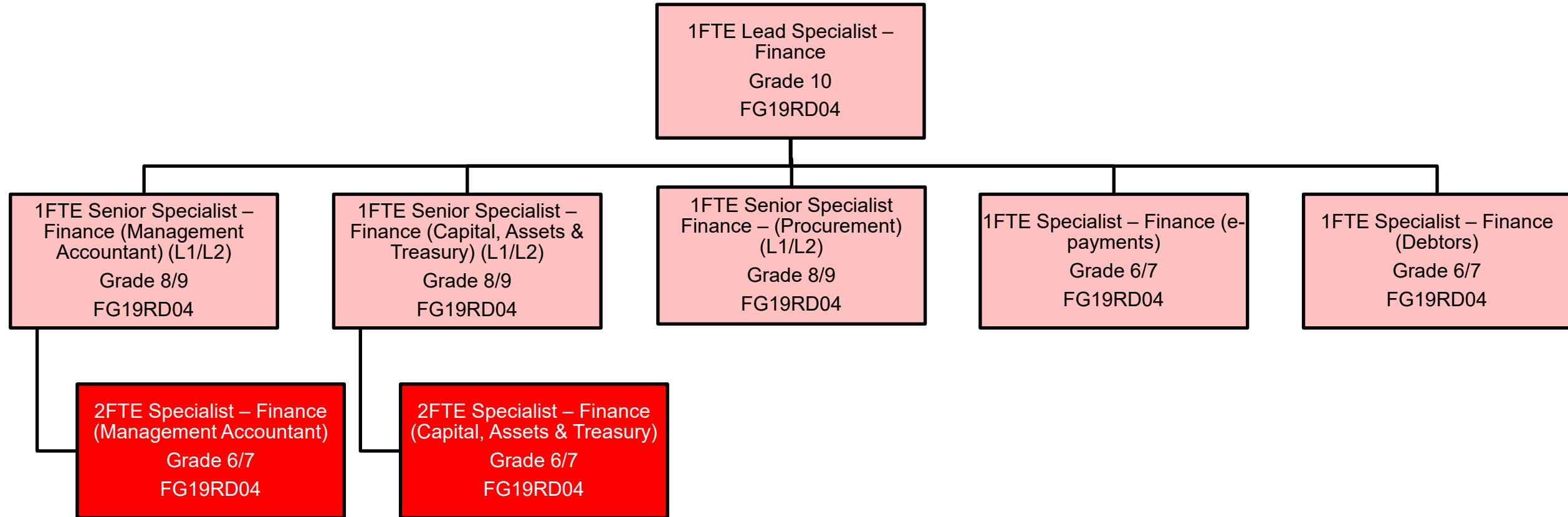

HR

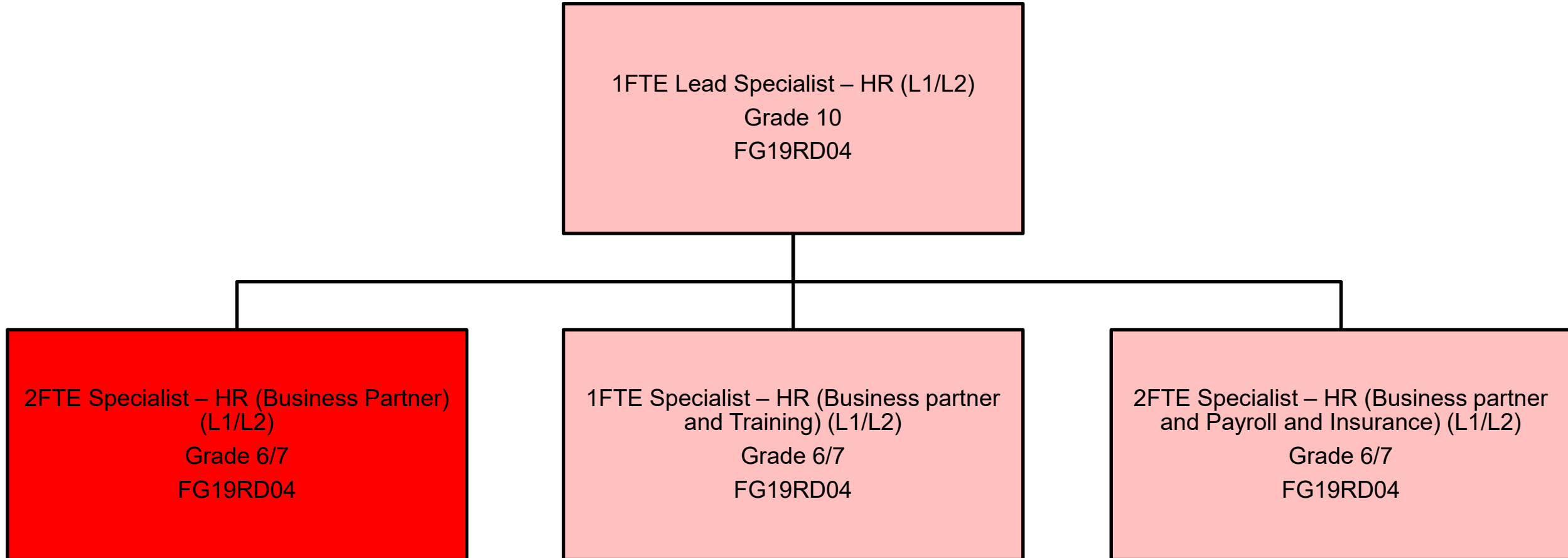

ICT

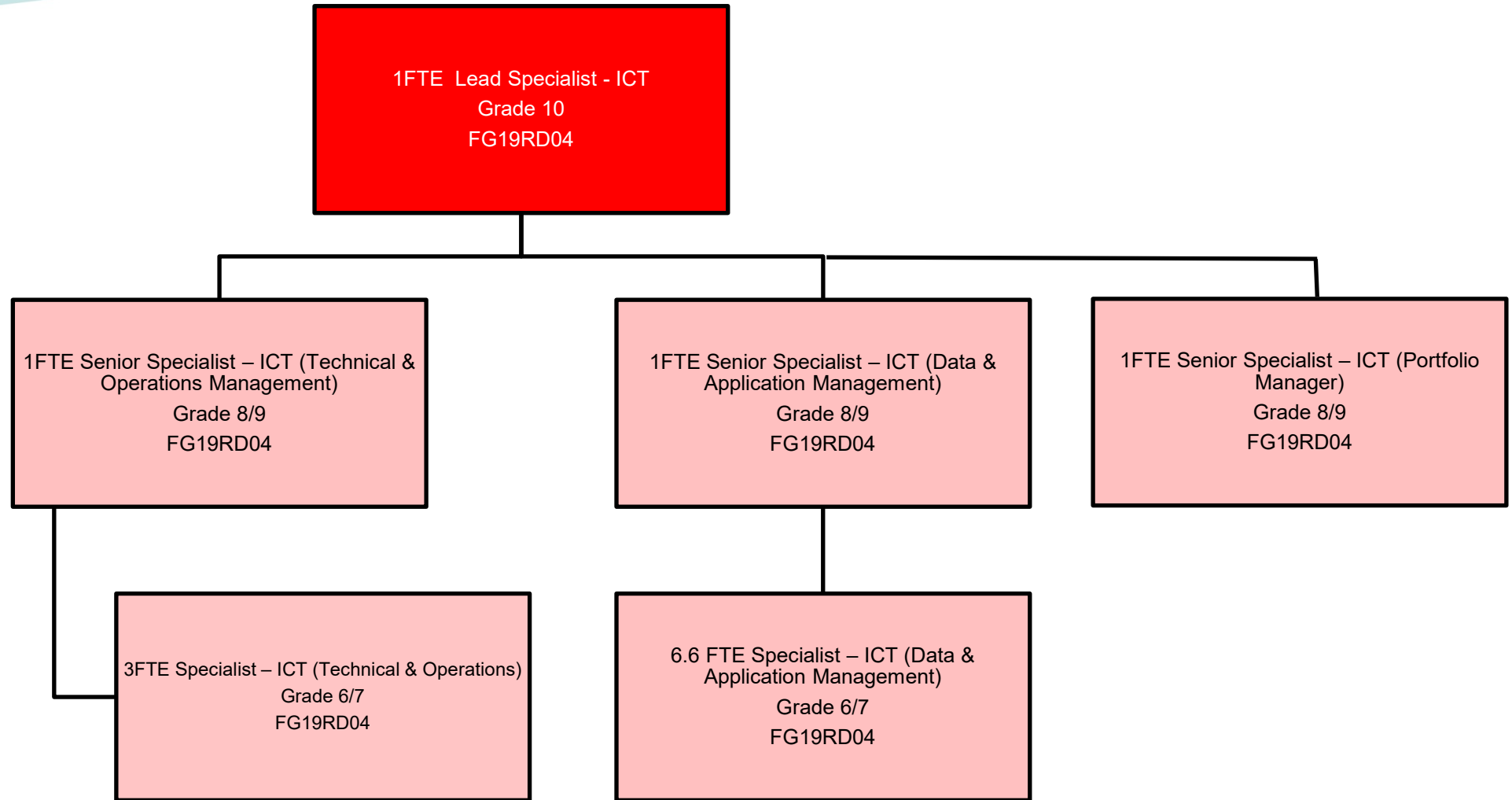

High level structure

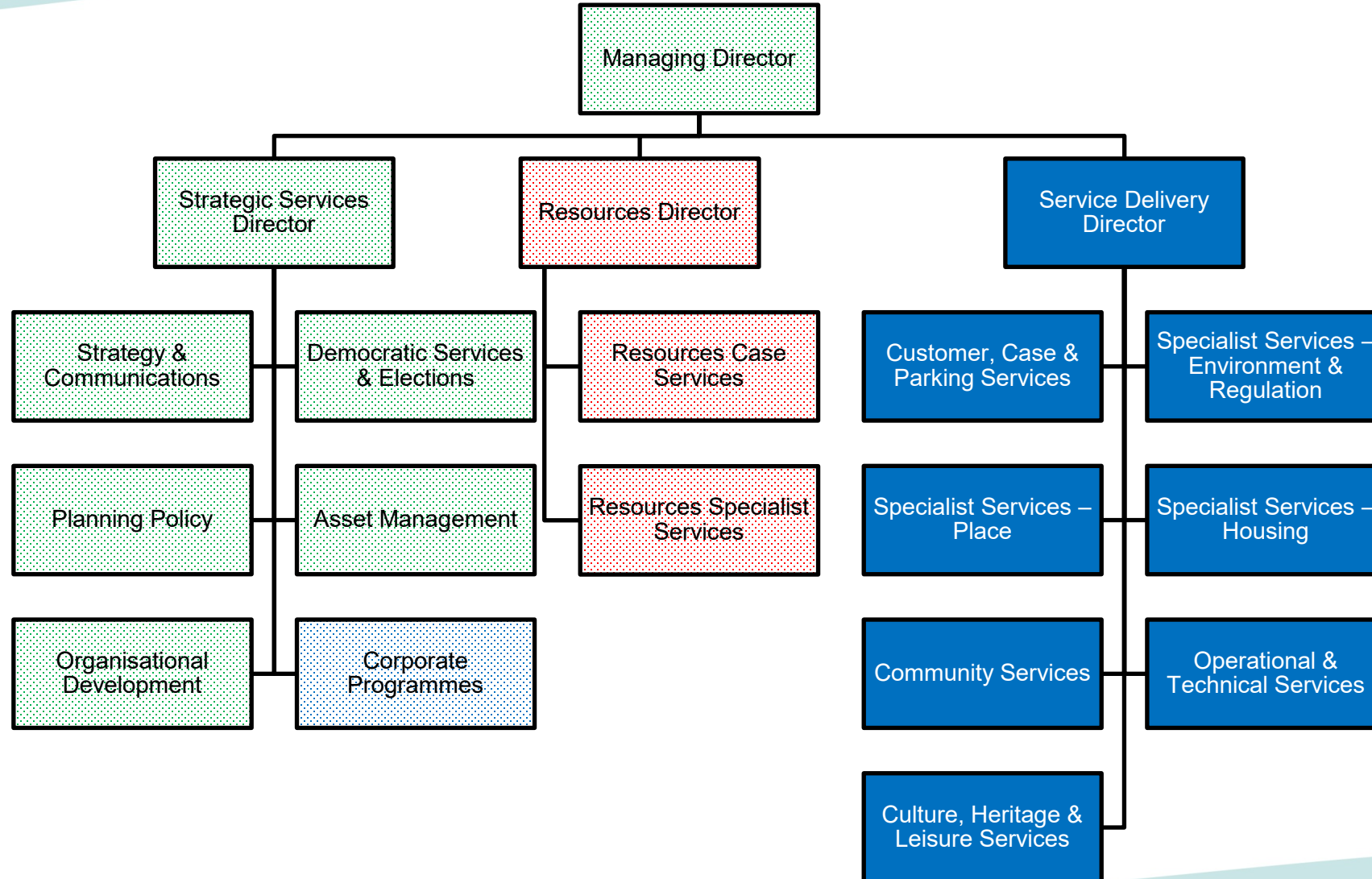

Customer, Case & Parking Services

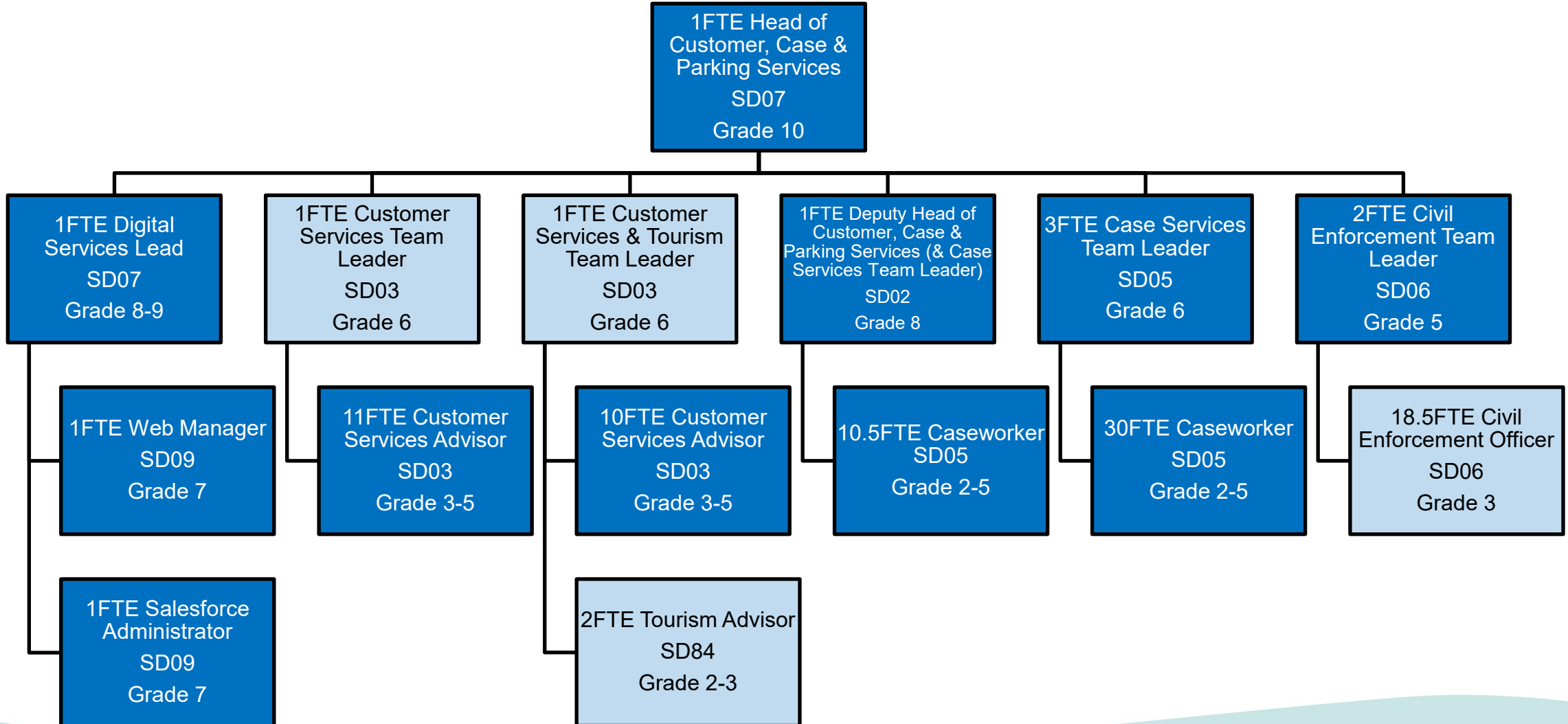

Specialist Services

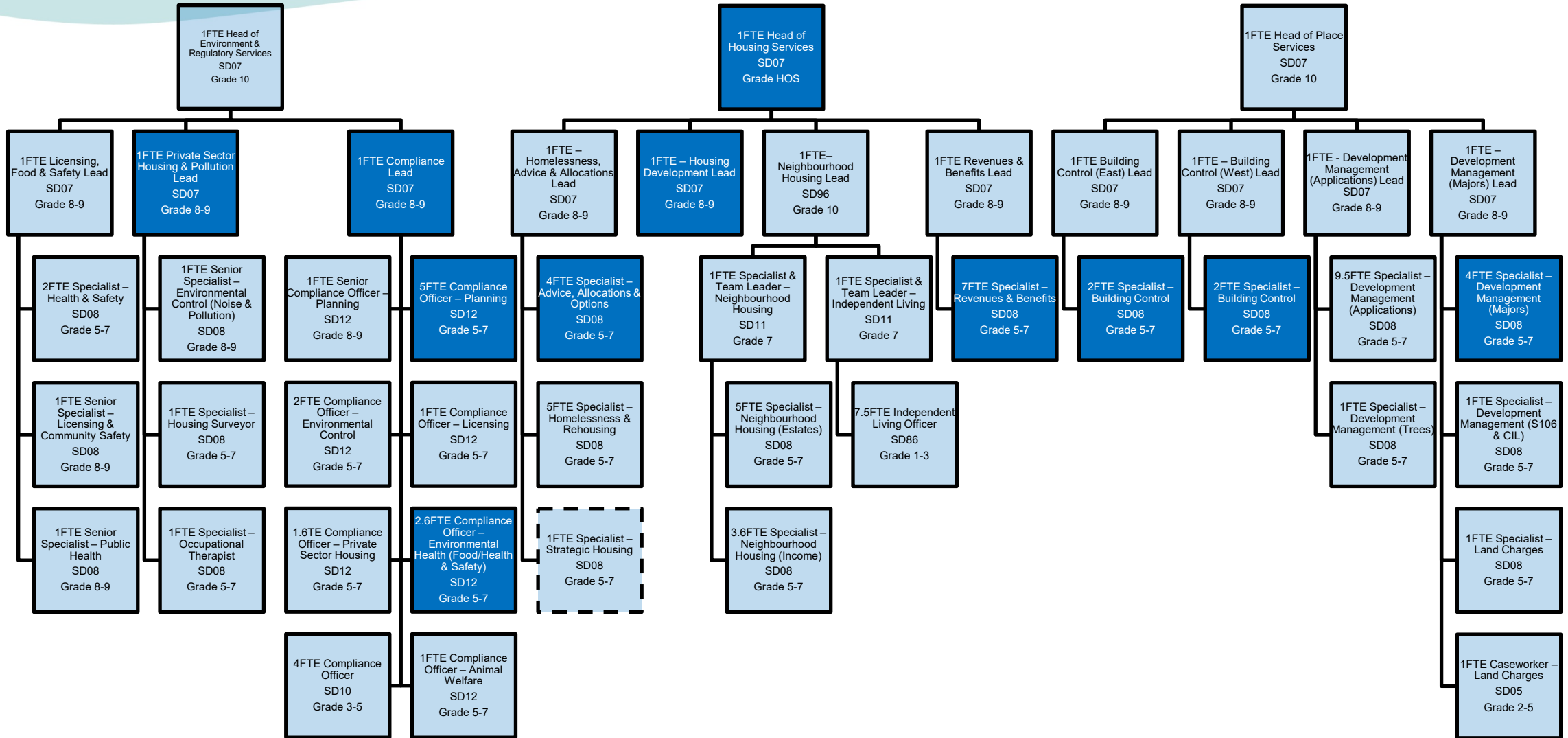

*0.5FTE substantive post, 1FTE with funding to 2021

Specialist Services – Environment & Regulatory

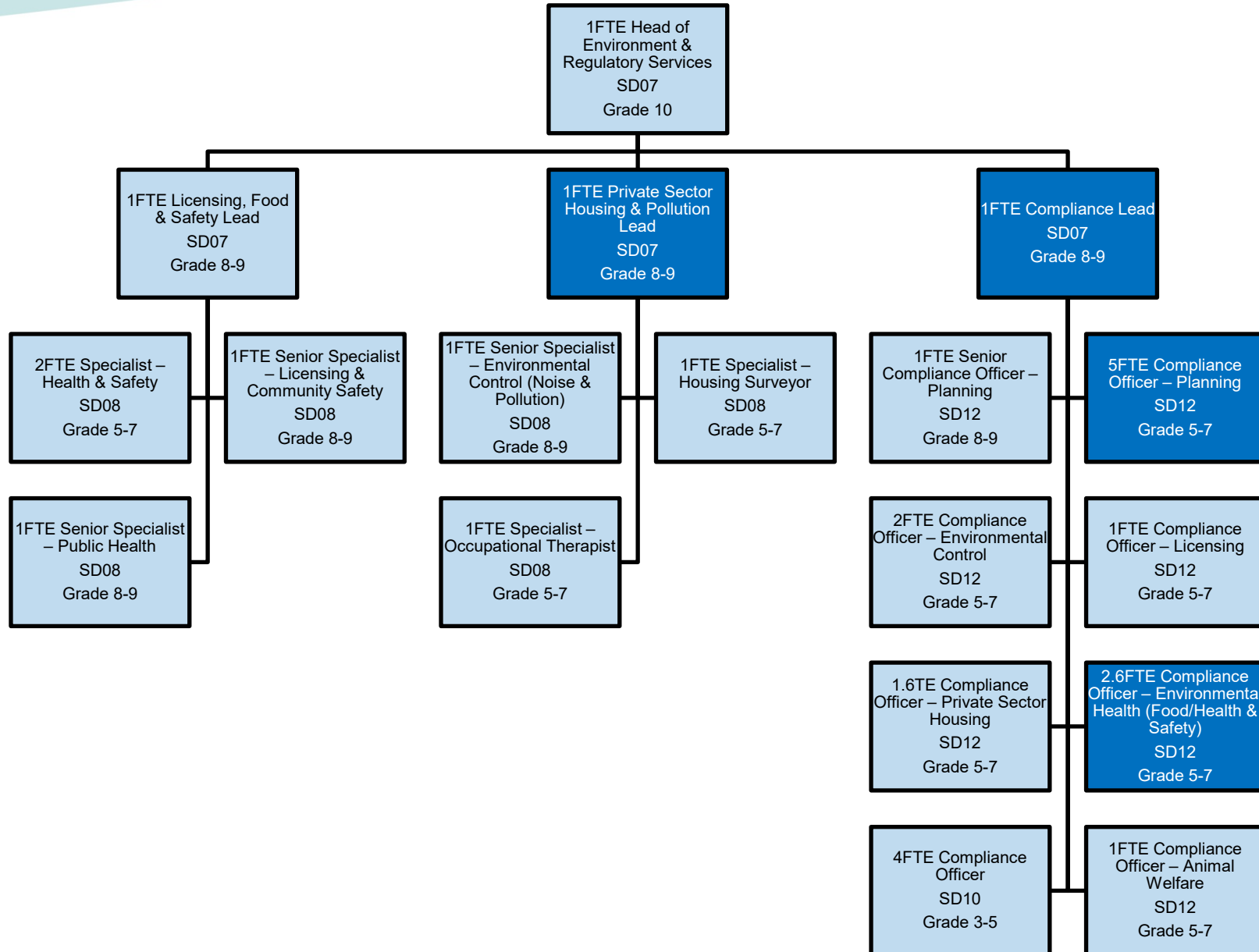

Specialist Services – Environment & Regulatory

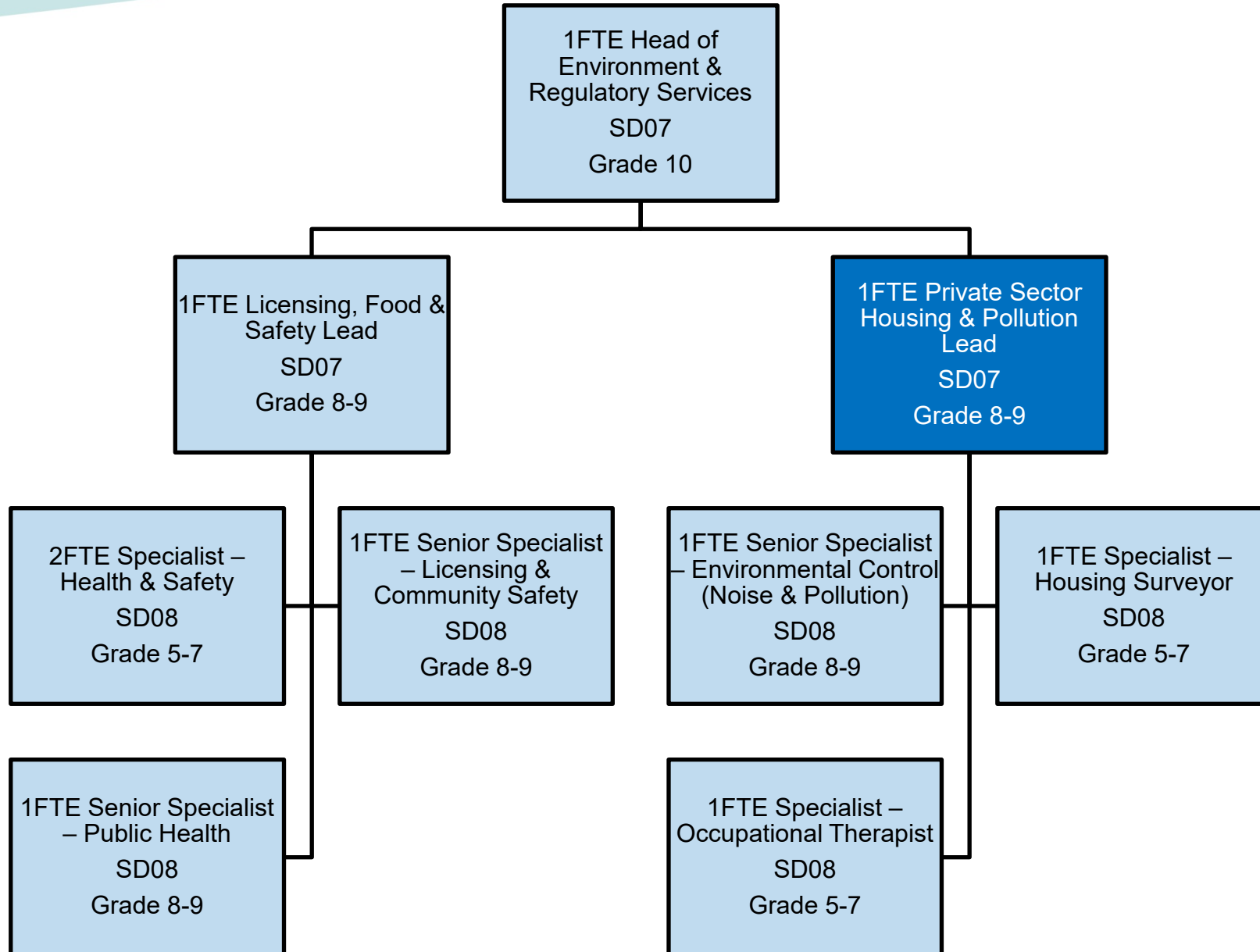

Compliance Services

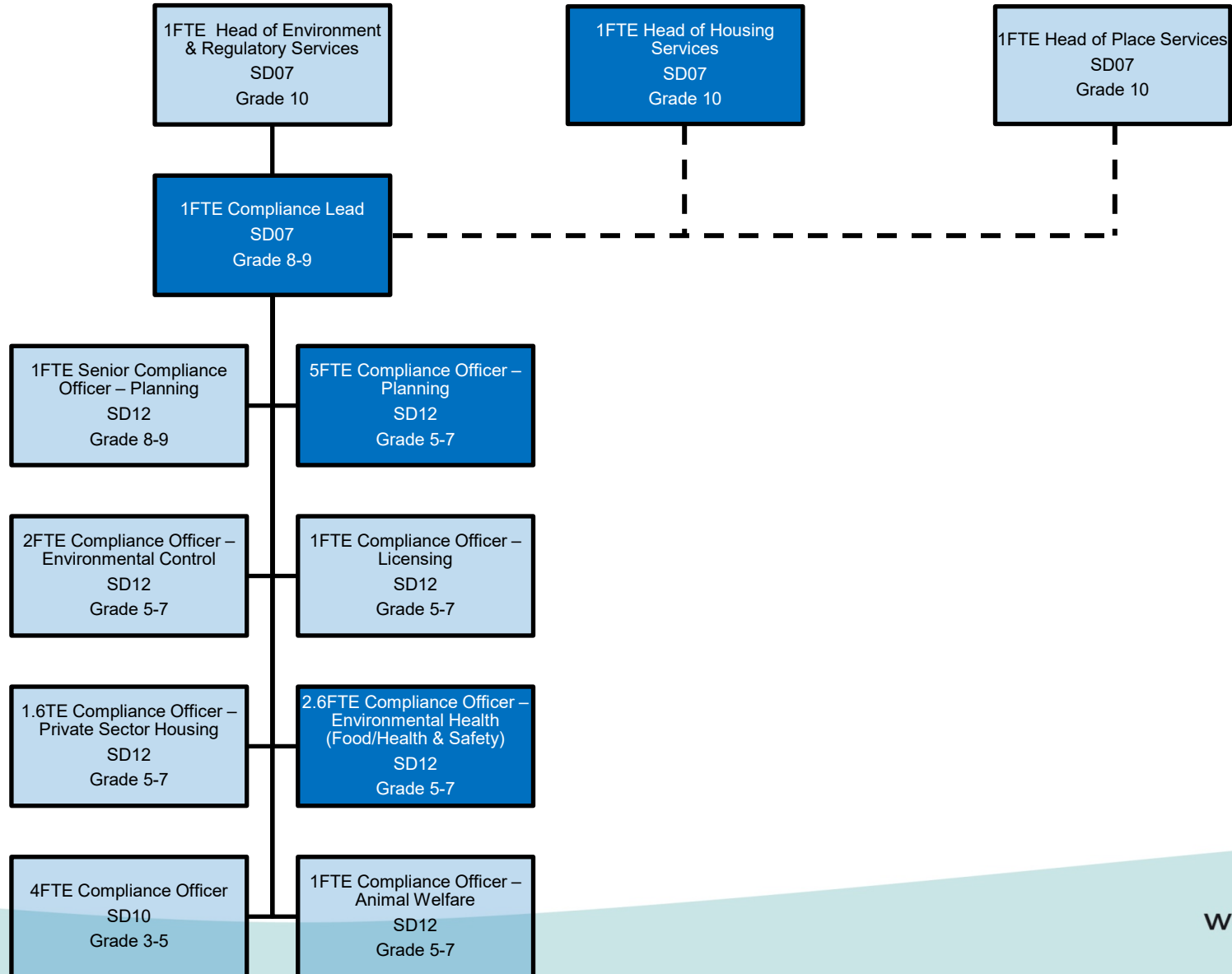

Specialist Services – Housing

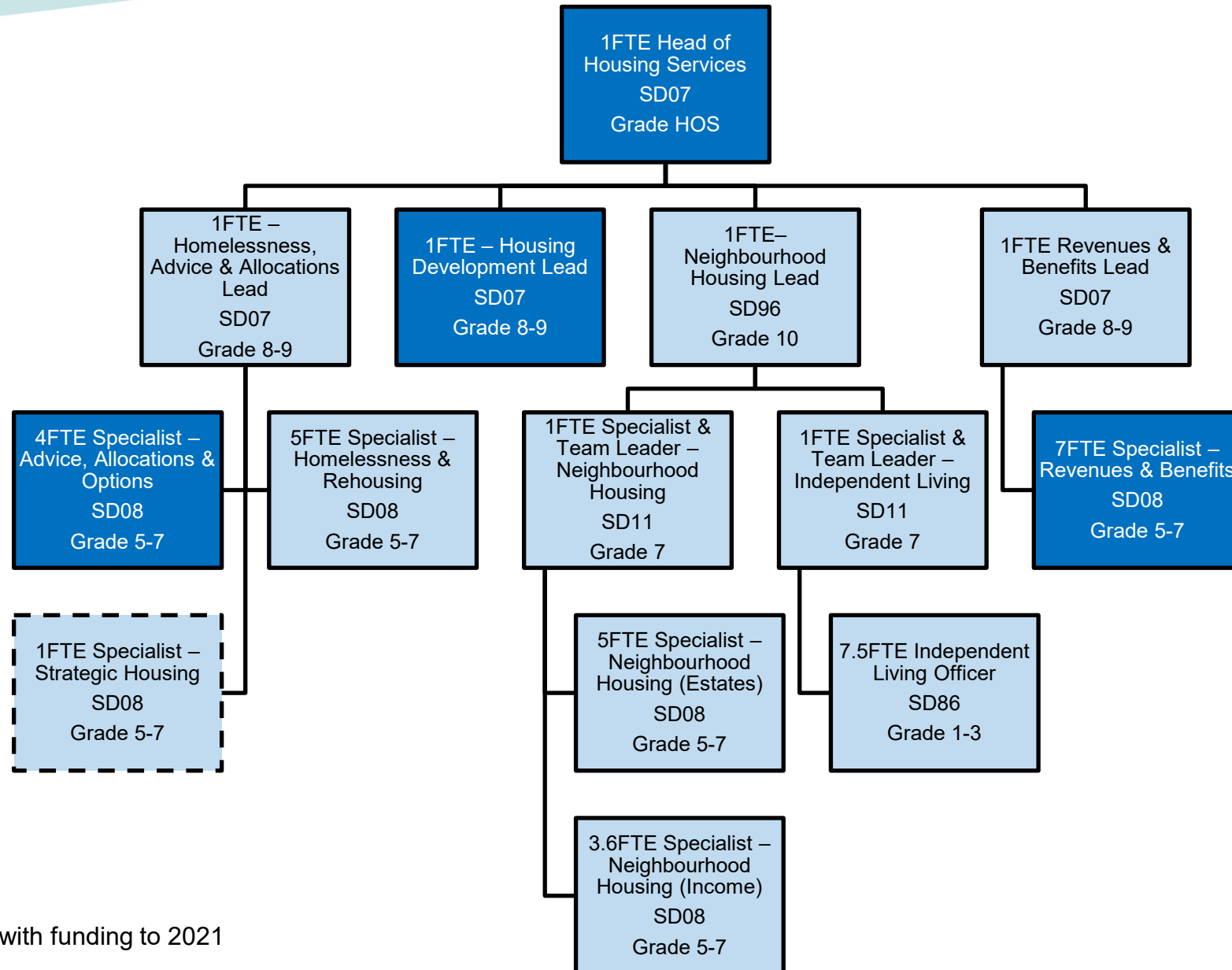

*0.5FTE substantive post, 1FTE with funding to 2021

Specialist Services - Place

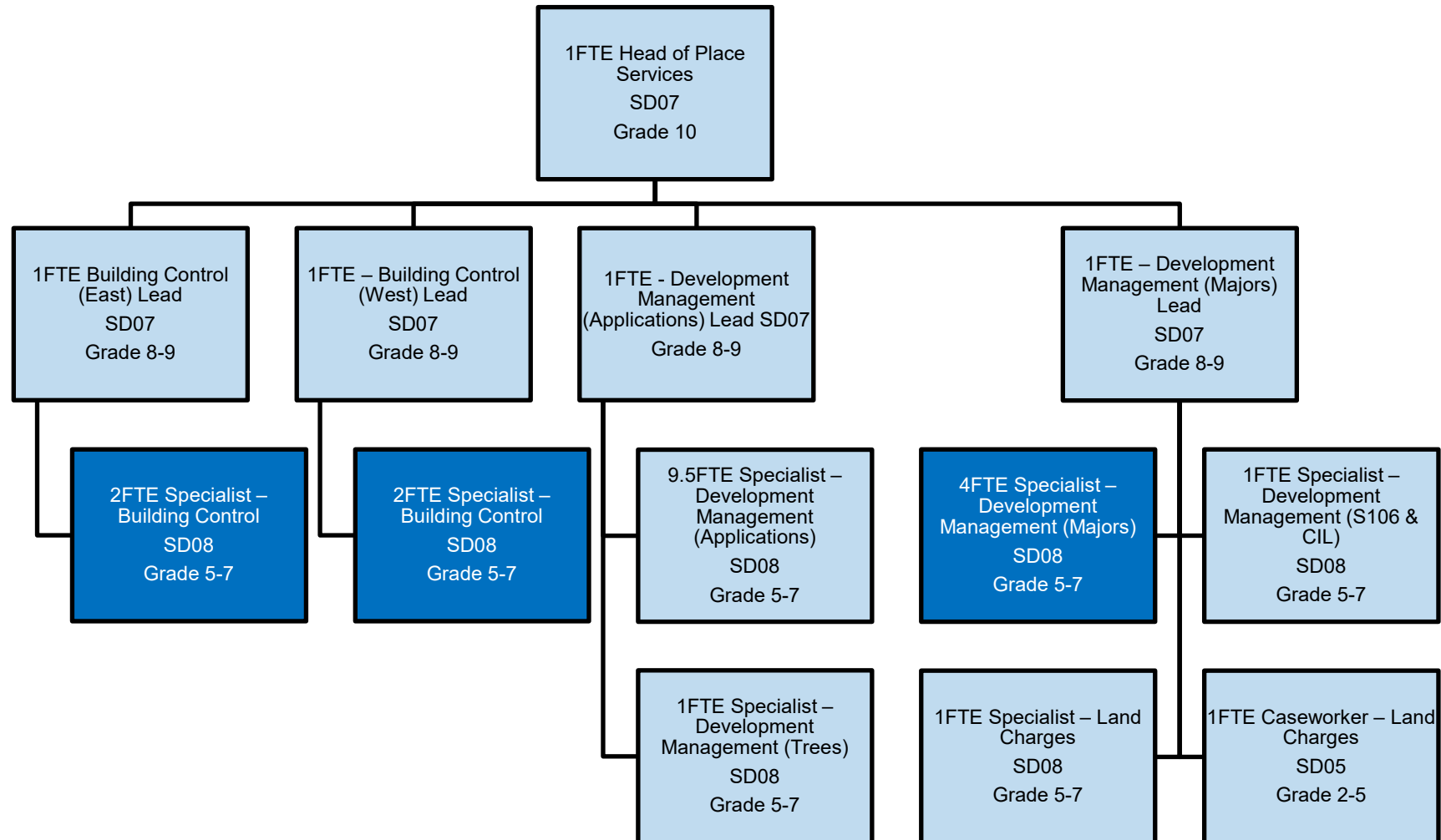

Community Services

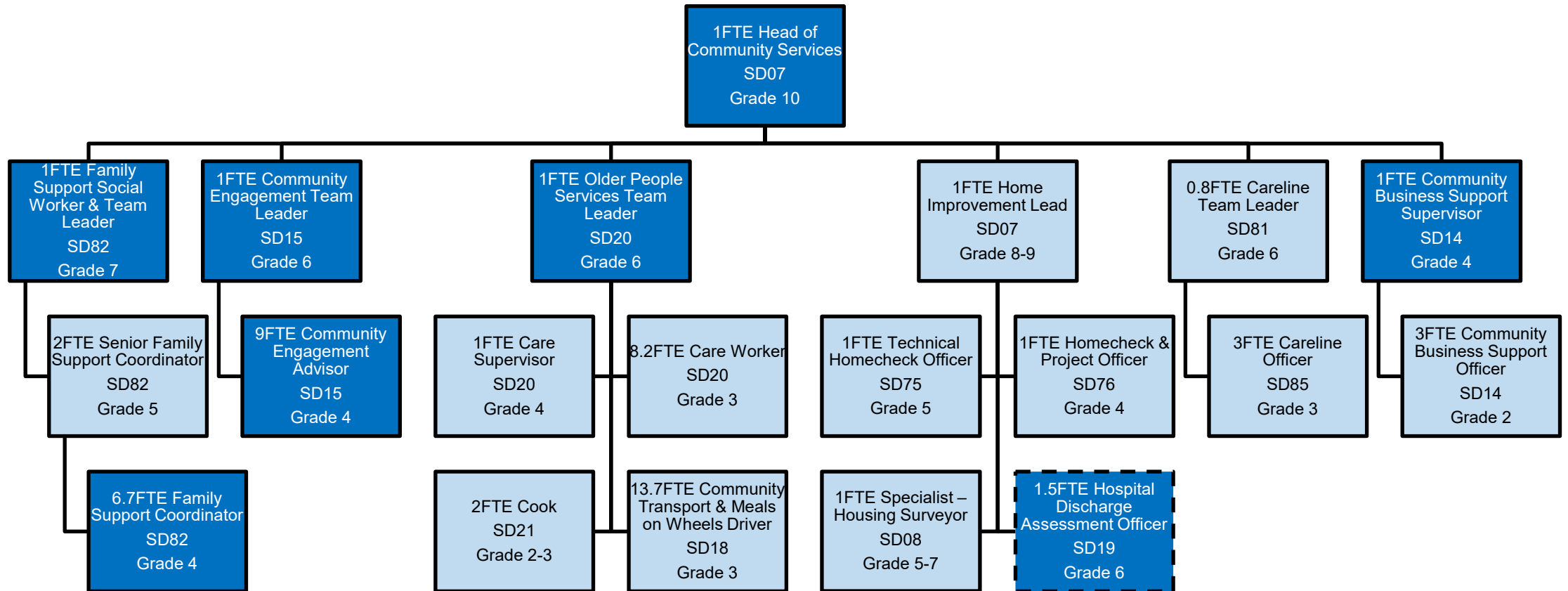

Operational & Technical Services

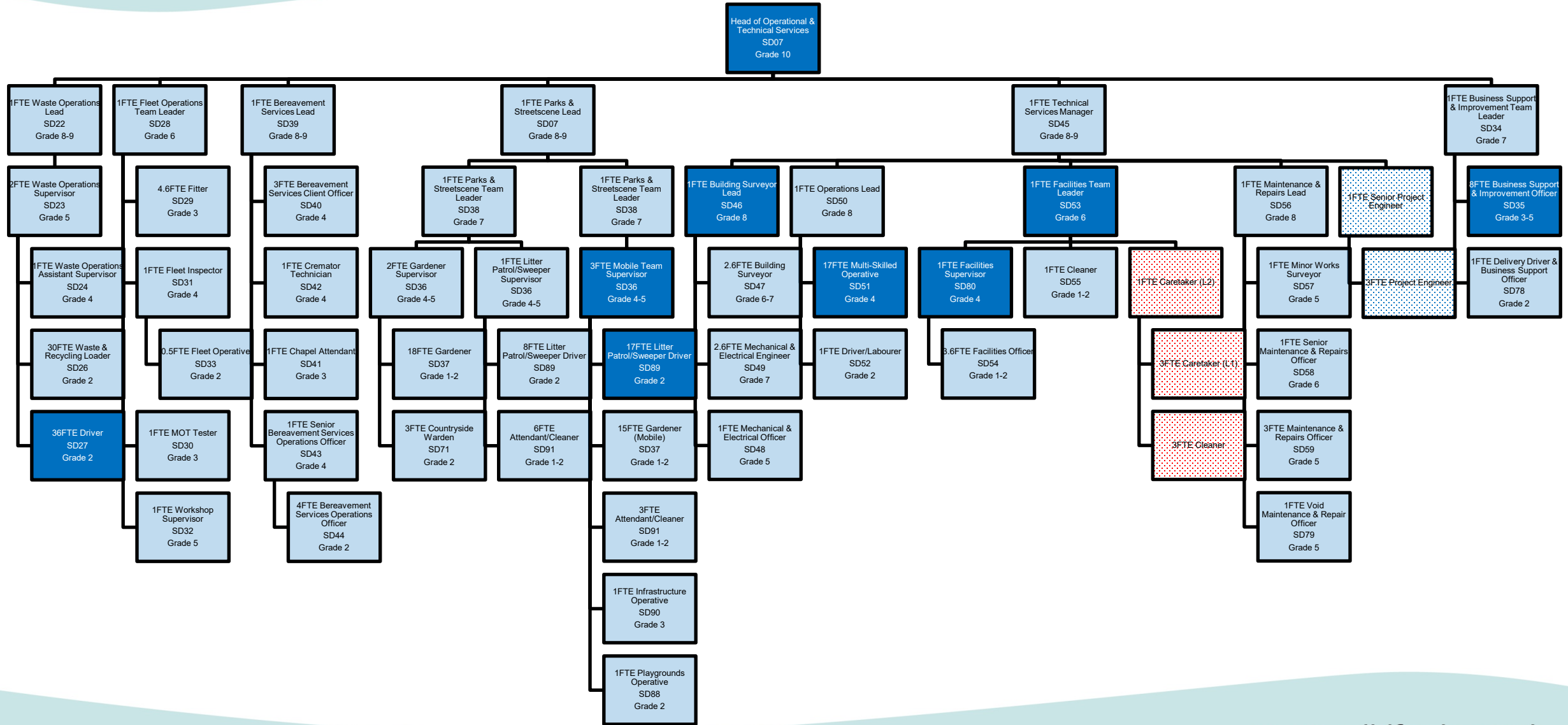

Waste Operations

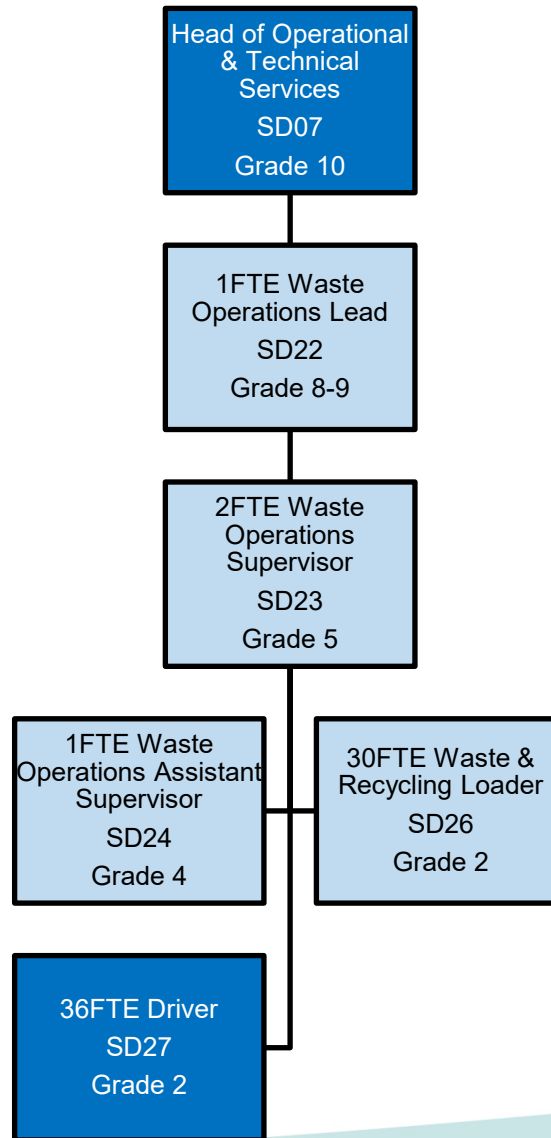

Fleet Operations

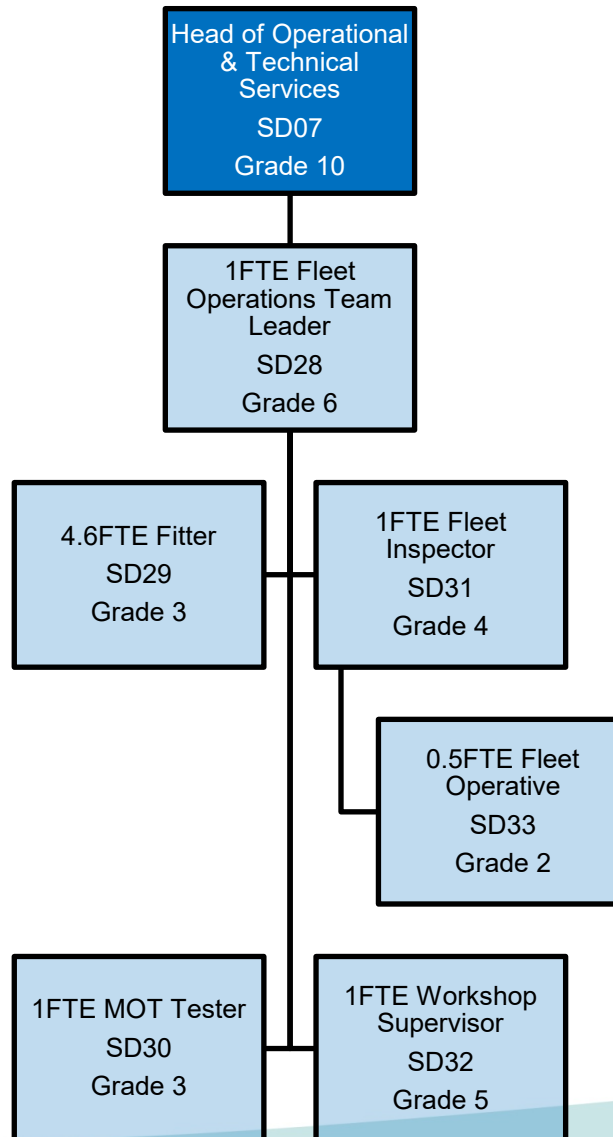

Bereavement Services

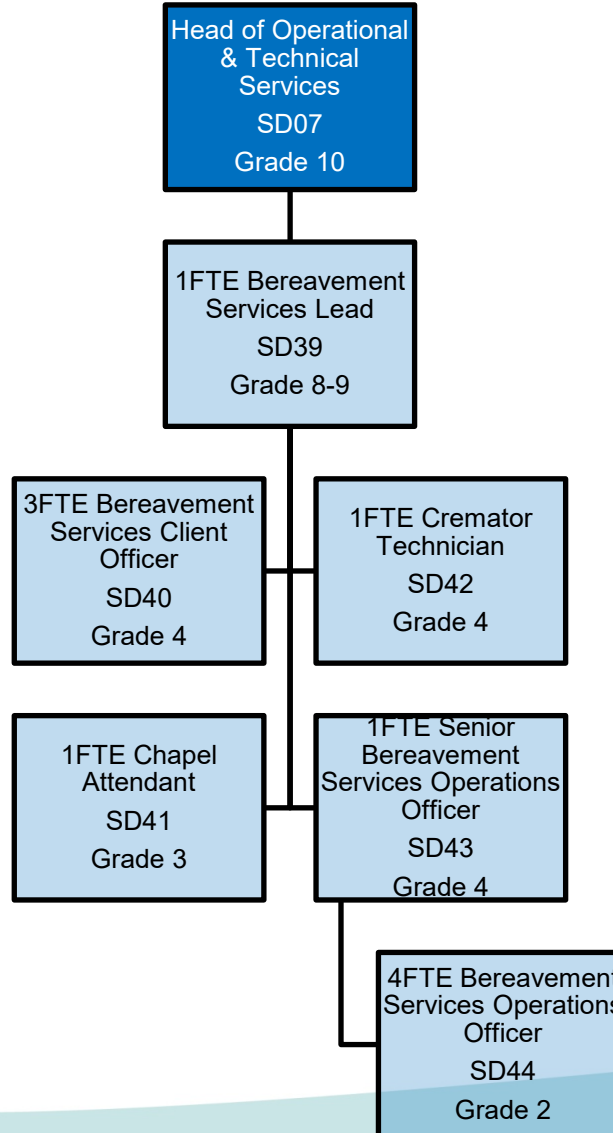

Parks & Streetscene

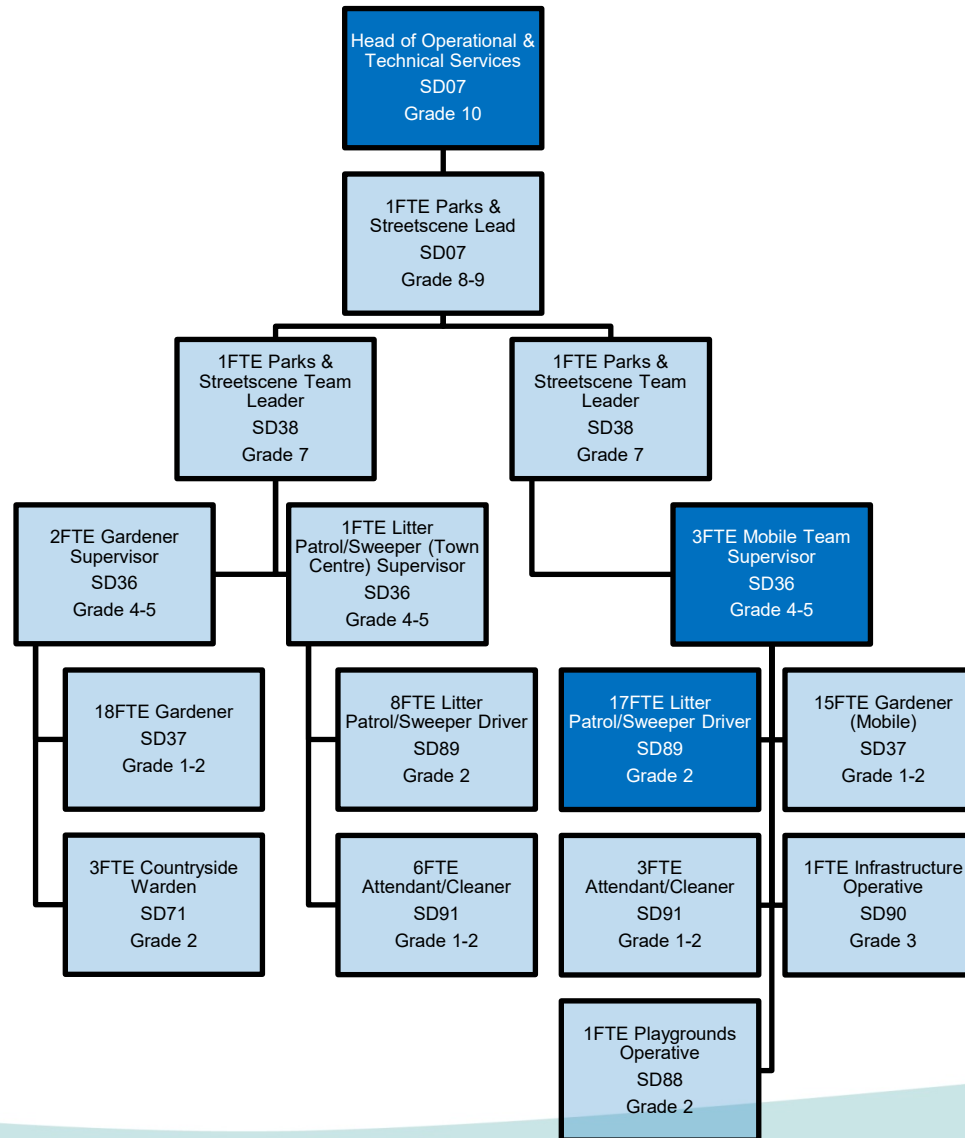

Technical Services

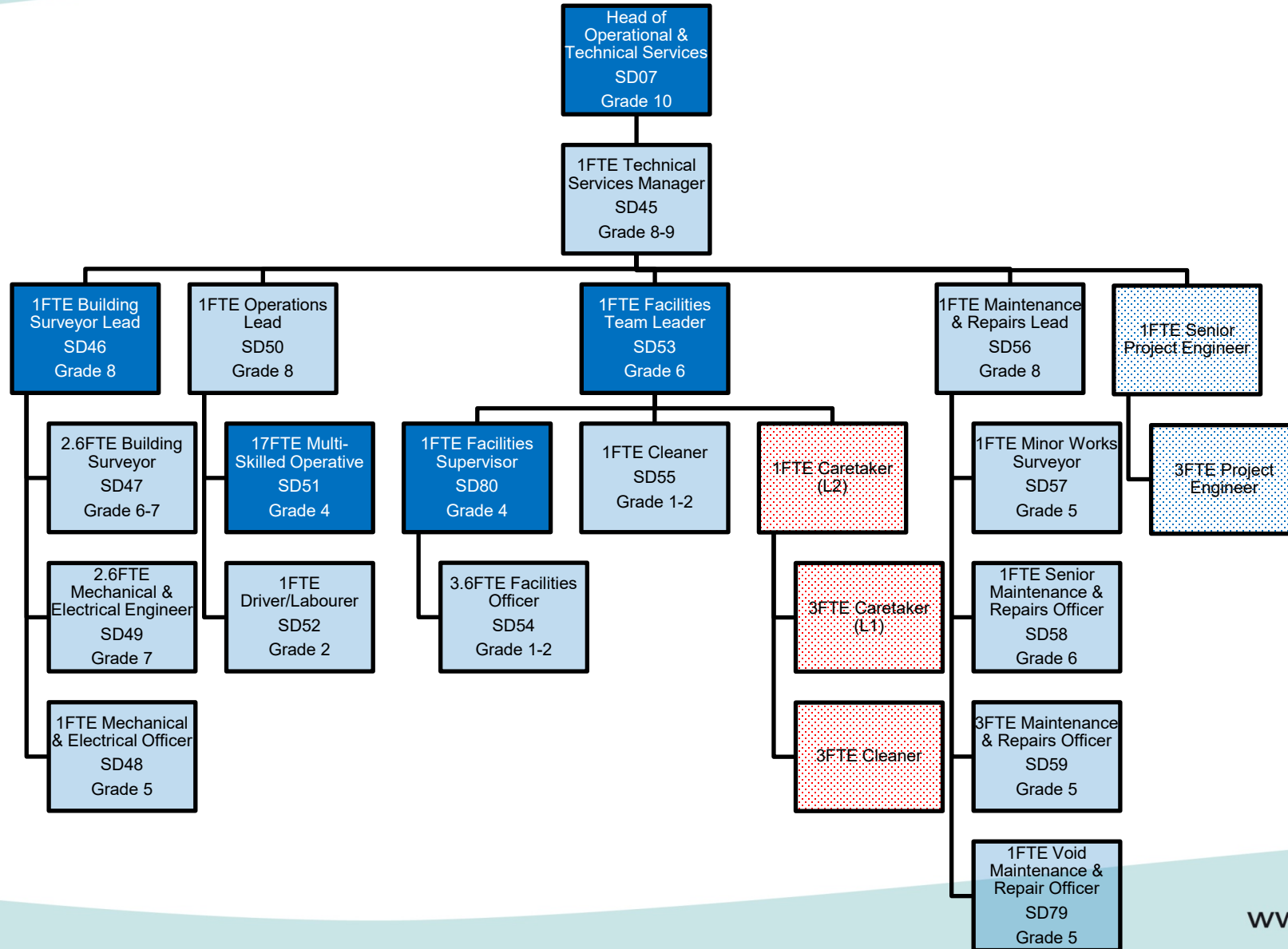

Business Support & Improvement

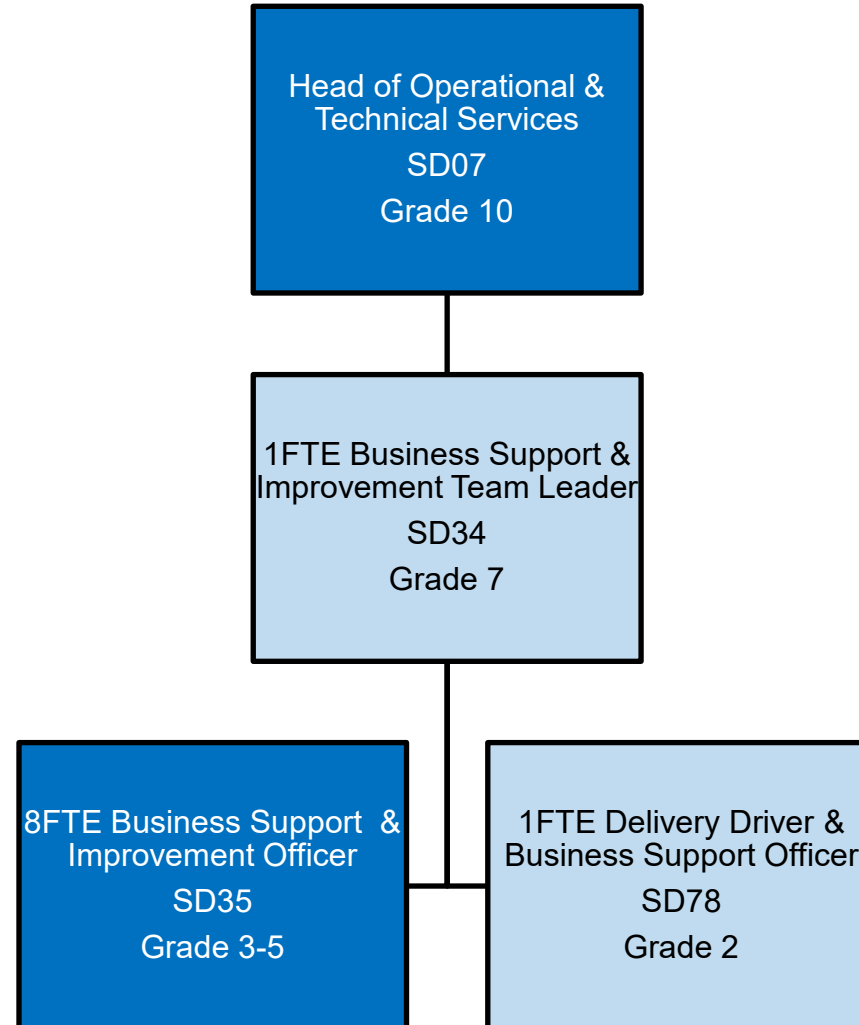

Culture & Heritage

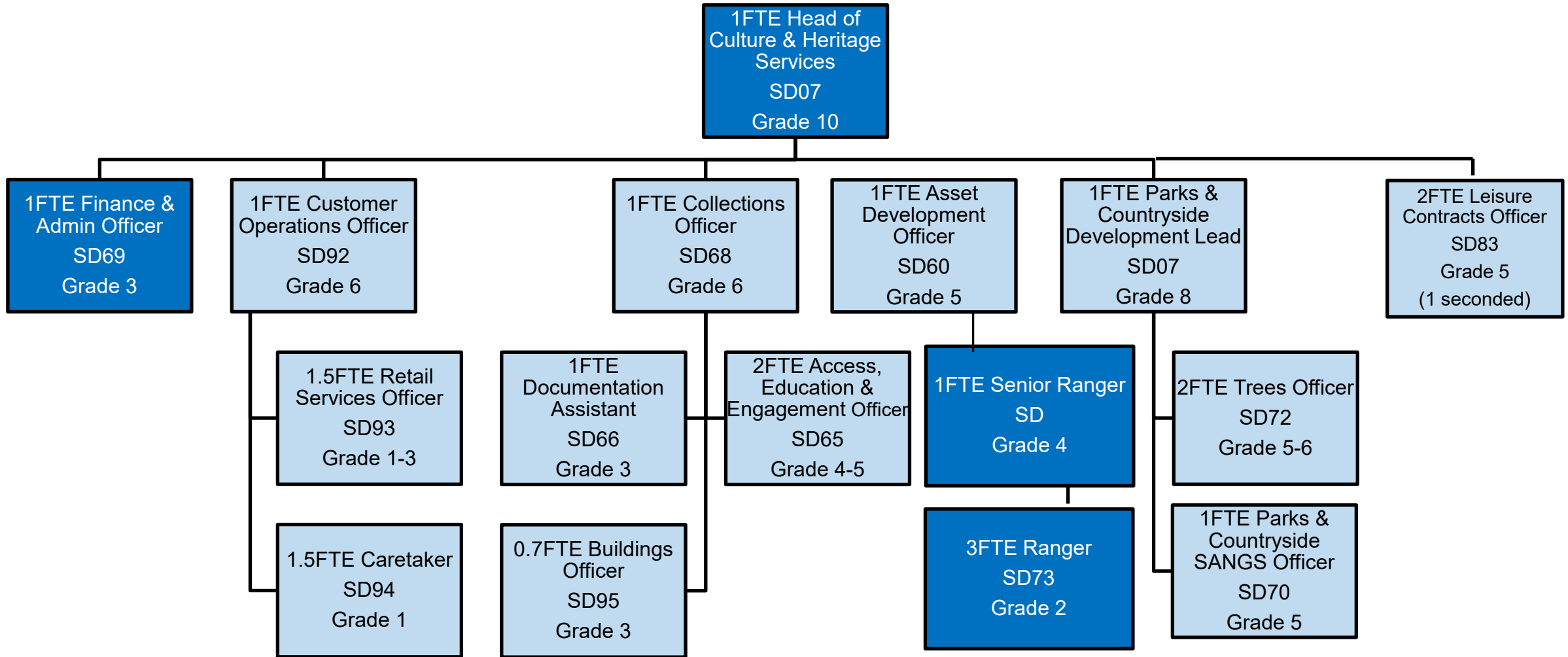

Other roles – strategy & communication

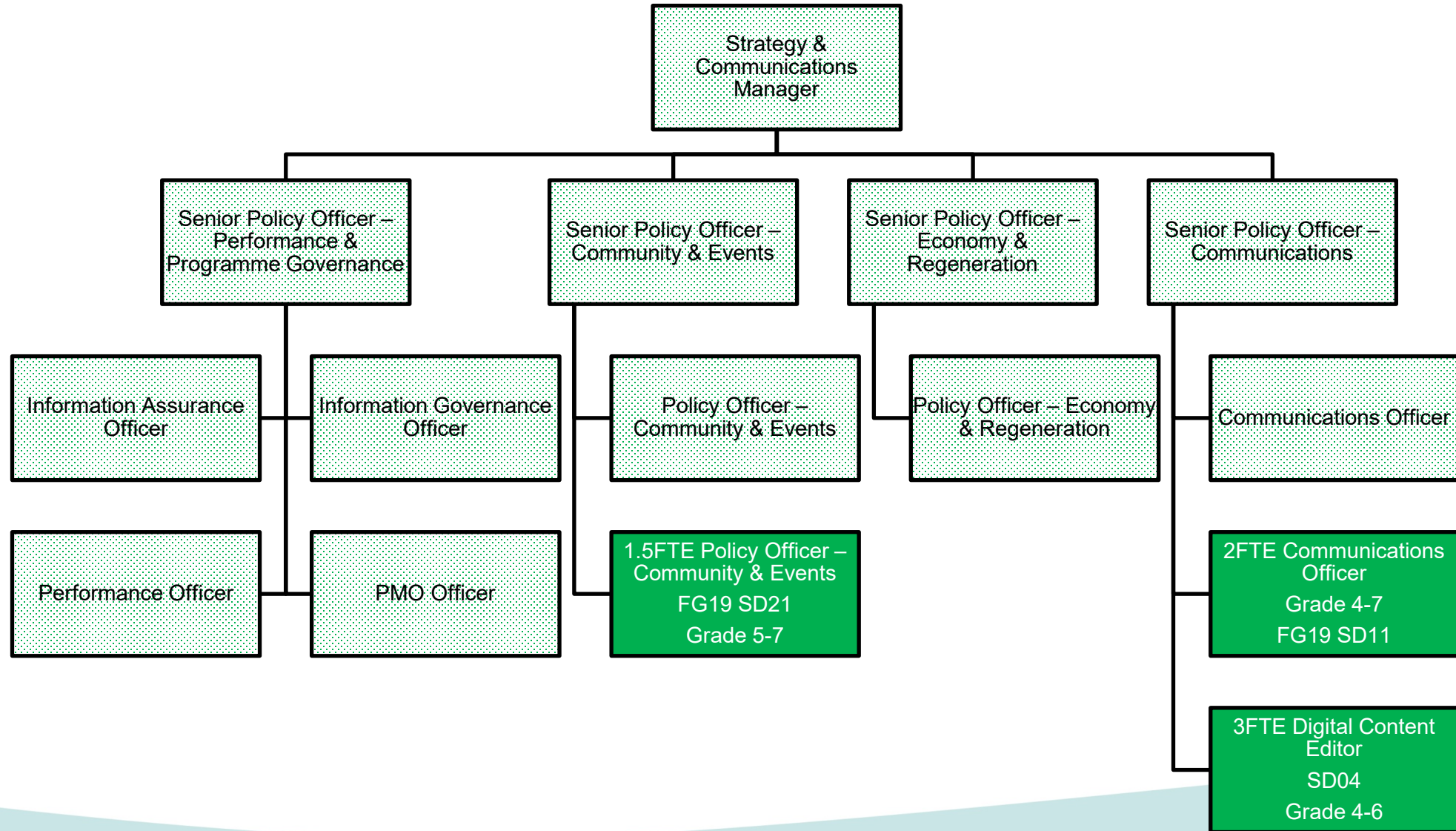

Other roles – corporate programmes

